

STENSBALLE

Sneskraber type FS 1300 M

Model 2004 - 25.11.2004

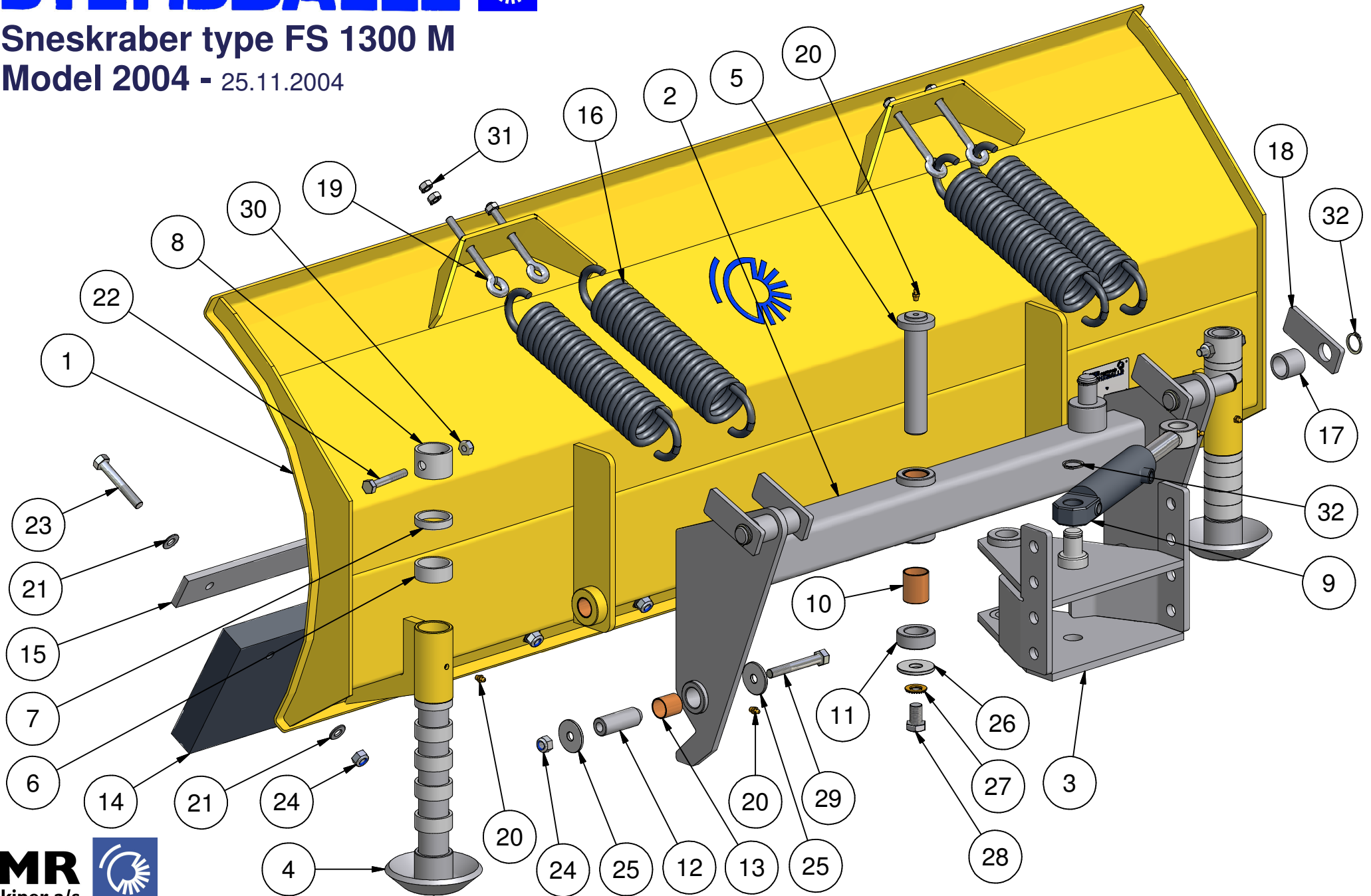

STENSBALLE



Sneskraber type FS 1300 M

Model 2004

25.11.2004

Pos.	Benævnelse	Antal	Res. nummer	Bemærkning
1	Sneblad	1	80-013-150	
2	Hovedbom	1	80-000-250	
3	Hulrækkeramme	1	80-000-350	
4	Slæbesko	2	80-000-020	
5	Drejenagle	1	80-113-010	
6	Afstandsring – 20mm	10	80-000-002	
7	Afstandsring – 10mm	4	80-000-003	
8	Spændering	2	80-000-001	
9	Cylinder	1	01-640-205	
10	Bronzebøsning	2	54-630-040	
11	Afstandsring for drejenagle	1	80-113-013	
12	Kipbøsning	2	80-013-001	
13	Bronzebøsning	4	54-625-030	
14	Gummiskær	1	80-013-006	
15	Holder for gummi	1	80-013-110	
16	Trækfjeder	4	61-699-525	
17	Fjederbøsning	4	80-000-005	
18	Fjederstop	4	80-000-004	
19	Øjebolt	4	30-910-100	
20	Smørenippel	5	57-000-008	
21	Facetskive	14	36-300-012	
22	Maskinbolt	2	28-110-070	
23	Maskinbolt	7	28-112-080	
24	Låsemøtrik	9	31-101-012	

STENSBALLE



Sneskraber type FS 1300 M

Model 2004

25.11.2004

Pos.	Benævnelse	Antal	Res. nummer	Bemærkning
25	Sværskive	4	36-150-012	
26	Sværskive	1	36-150-016	
27	Contact-skive	1	35-200-016	
28	Sætskrue	1	29-116-025	
29	Maskinbolt	2	28-112-090	
30	Låsemøtrik	2	31-101-010	
31	Møtrik	8	31-001-010	
32	Låsering	6	20-101-025	
33				
34				
35				
36				
37				
38				
39				
40				
41				
42				
43				
44				
45				
46				
47				